

Standard Recovery Diodes (Hockey PUK Version), 4535A

FEATURES

- Wide current range
- Voltage ratings: 200V to 600V
- High surge current capabilities
- Diffused junction
- Hockey PUK version
- Case style DO-220AC(K-PUK), Nell's D-type Capsule
- Lead (Pb)-free

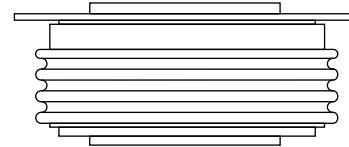

DO-220AC(K-PUK)
(Nell's D-type Capsule)

TYPICAL APPLICATIONS

- Converters
- Power supplies
- Machine tool controls
- High power drives
- Medium traction applications

PRODUCT SUMMARY	
$I_{F(AV)}$	4535A

MAJOR RATINGS AND CHARACTERISTICS			
PARAMETER	TEST CONDITIONS	VALUES	UNIT
$I_{F(AV)}$		4535	A
	T_{hs}	55	°C
$I_{F(RMS)}$		8200	A
	T_{hs}	25	°C
I_{FSM}	50 HZ	44000	A
	60 HZ	46070	
I^2t	50 HZ	9680	kA ² s
	60 HZ	8808	
V_{RRM}		200 to 600	V
T_J	Typical	-40 to 190	°C

ELECTRICAL SPECIFICATIONS

VOLTAGE RATINGS				
TYPE NUMBER	VOLTAGE CODE	V_{RRM} , MAXIMUM REPETITIVE PEAK REVERSE VOLTAGE V	V_{RSM} , MAXIMUM NON-REPETITIVE PEAK REVERSE VOLTAGE V	I_{RRM} , MAXIMUM AT $T_J = T_J$ MAXIMUM mA
D4535D	02	200	300	50
	04	400	500	
	06	600	700	

FORWARD CONDUCTION					
PARAMETER	SYMBOL	TEST CONDITIONS		VALUES	UNIT
Maximum average forward current at heatsink temperature	$I_{F(AV)}$	180° conduction, half sine wave Double side (single side) cooled		4535(2300)	A
				55(85)	°C
Maximum RMS forward current	$I_{F(RMS)}$	25°C heatsink temperature double side cooled		8200	A
Maximum peak, one cycle non-repetitive surge current	I_{FSM}	t = 10ms	No voltage reapplied	44000	A
		t = 8.3ms		46070	
		t = 10ms	100% V_{RRM} reapplied	36960	
		t = 8.3ms		38700	
Maximum I^2t for fusing	I^2t	t = 10ms	No voltage reapplied	9680	kA ² s
		t = 8.3ms		8808	
		t = 10ms	100% V_{RRM} reapplied	6830	
		t = 8.3ms		6215	
Maximum $I^2\sqrt{t}$ for fusing	$I^2\sqrt{t}$	t = 0.1 to 10 ms, no voltage reapplied		96800	kA ² √s
Maximum value of threshold voltage	$V_{F(TO)}$	$I_{FM} = 13630A, T_J = T_J$ maximum		0.770	V
Maximum value of forward slope resistance	r_t			0.055	mΩ
Maximum forward voltage drop	V_{FM}	$I_{pk} = 6400A$	$T_J = T_J$ maximum	1.10	V
		$I_{pk} = 13630A$		1.40	

THERMAL AND MECHANICAL SPECIFICATIONS				
PARAMETER	SYMBOL	TEST CONDITIONS	VALUES	UNIT
Maximum junction operating temperature range	T_J		-40 to 190	°C
Maximum storage temperature range	T_{stg}		-55 to 200	
Maximum thermal resistance, junction to heatsink	R_{thJ-hs}	DC operation single side cooled	0.044	K/W
		DC operation double side cooled	0.022	
Mounting force, ±10%			22250 (2250)	N (kg)
Approximate weight			425	g
Case style		TO-200AC (K-PUK), Nell's D-type Capsule		

△ R_{thJC} CONDUCTION						
CONDUCTION ANGEL	SINUSOIDAL CONDUCTION		RECTANGULAR CONDUCTION		TEST CONDUCTIONS	UNITS
	SINGLE SIDE	DOUBLE SIDE	SINGLE SIDE	DOUBLE SIDE		
180°	0.002	0.002	0.001	0.001	$T_J = T_J$ maximum	K/W
120°	0.002	0.002	0.002	0.002		
90°	0.003	0.003	0.003	0.003		
60°	0.004	0.004	0.004	0.004		
30°	0.007	0.007	0.007	0.007		

Note

• The table above shows the increment of thermal resistance R_{thJ-hs} when devices operate at different conduction angles than DC

Fig.1 Current ratings characteristics

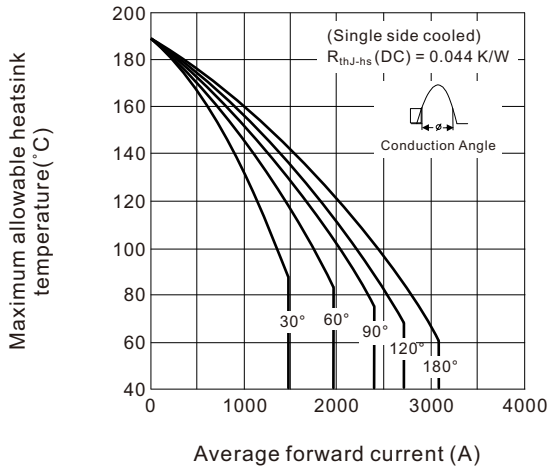

Fig.2 Current ratings characteristics

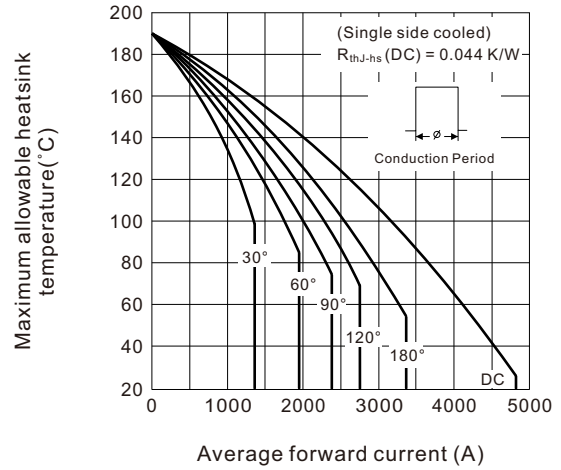

Fig.3 Current ratings characteristics

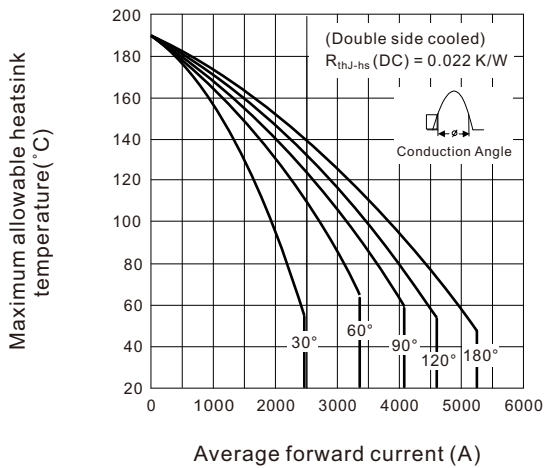

Fig.4 Current ratings characteristics

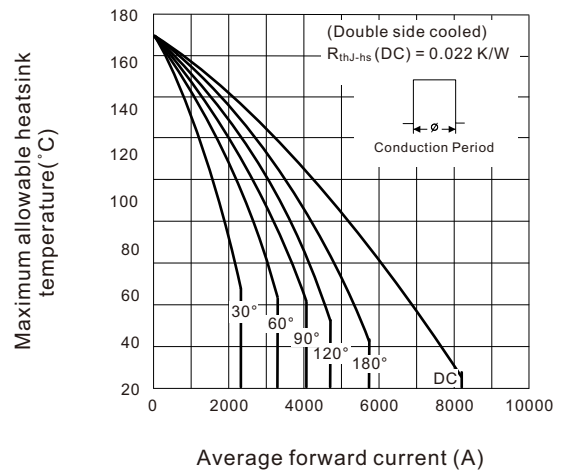

Fig.5 Forward power loss characteristics

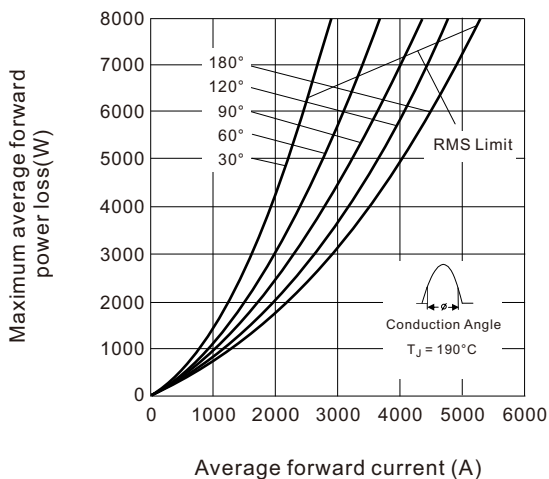

Fig.6 Forward power loss characteristics

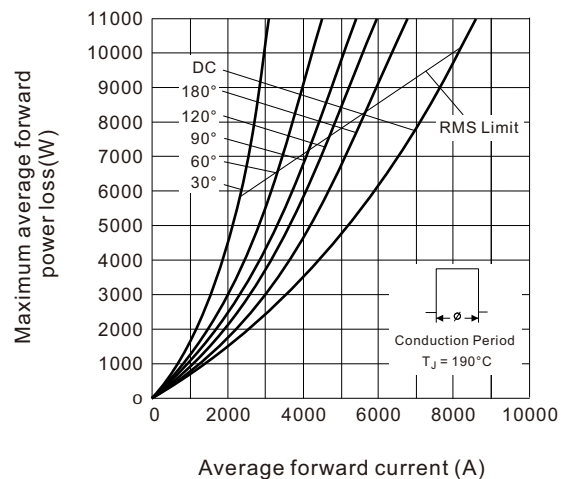

Fig.7 Maximum non-repetitive surge current single and double side cooled

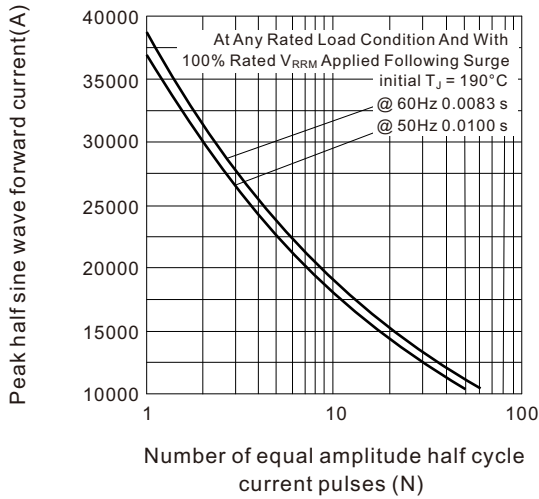

Fig.8 Maximum non-repetitive surge current single and double side cooled

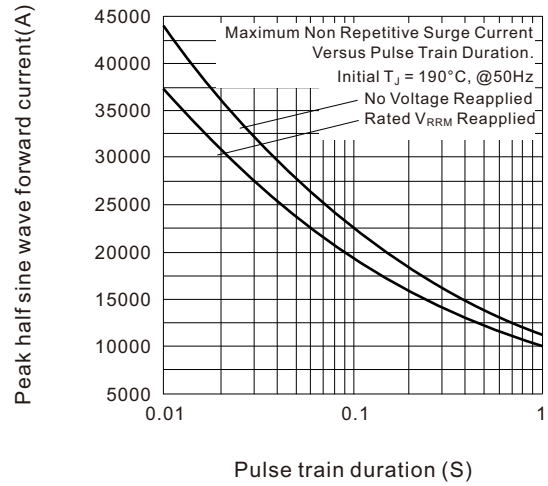

Fig.9 Forward voltage drop characteristics

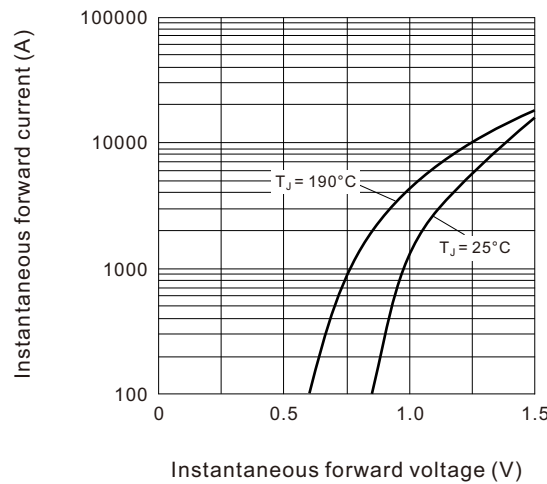
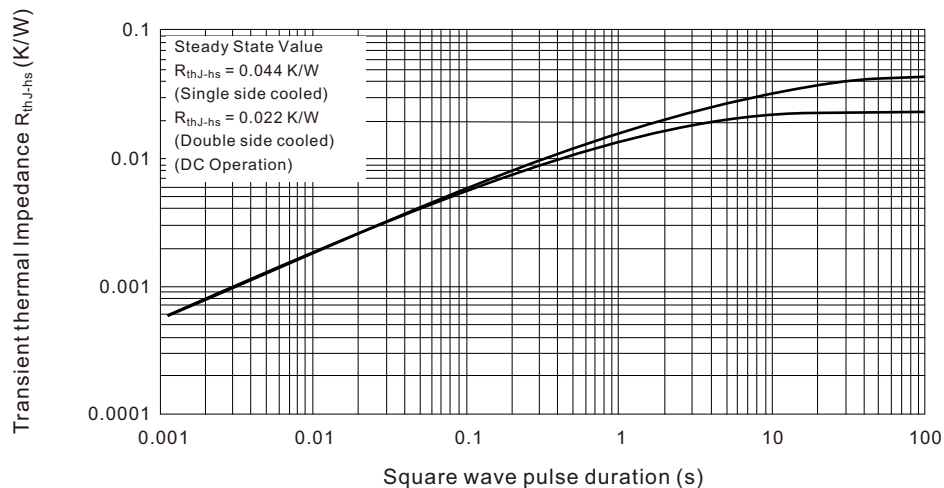

Fig.10 Thermal Impedance R_{thJ-hs} characteristics



ORDERING INFORMATION TABLE

Device code	D	4535	D	06
	①	②	③	④

- ① - "D" for standard recovery diode
- ② - Maximum average forward current, "4535" for 4535A
- ③ - Case style : "D" for Nell's D-type Capsule, DO-200AC (K-PUK)
- ④ - Voltage code, code x 100 = V_{RRM}

DO-220AC (K-PUK), Nell's D-type Capsule

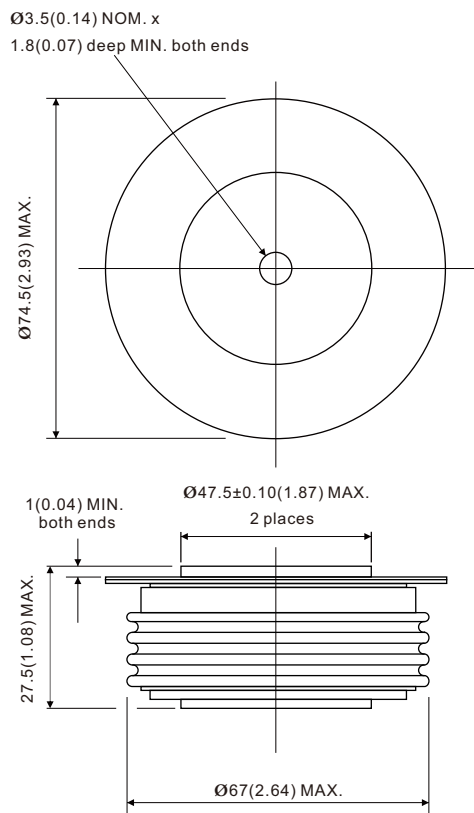

All dimensions in millimeters (inches)

